

SPL6

MULTIBAND LIMITER & SOUND LEVEL RECORDER

Manual

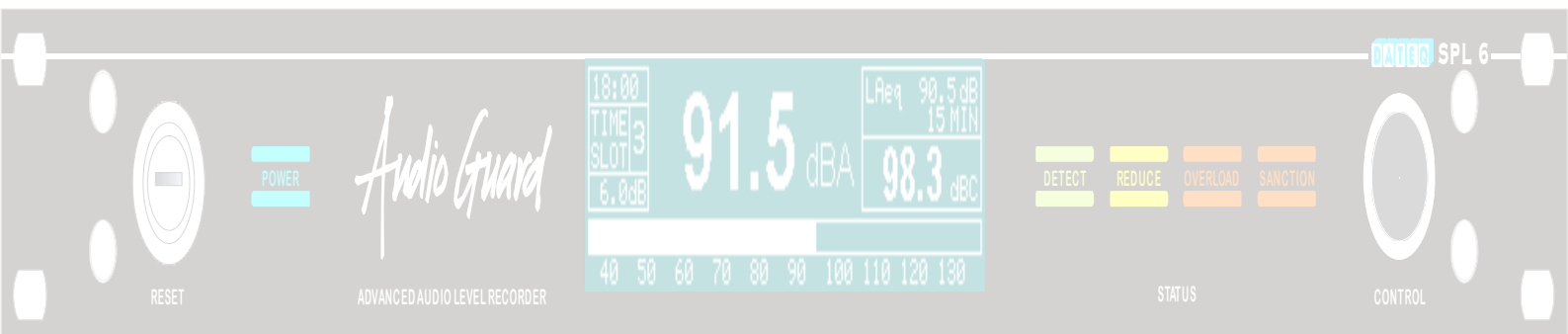

Safety instructions

1. All safety instructions, warnings and operating instructions must be read first.
2. All warnings on the equipment must be heeded.
3. The operating instructions must be followed.
4. Keep the operating instructions for future reference.
5. The equipment may never be used in the immediate vicinity of water; make sure that water and damp cannot get into the equipment.
6. The equipment may only be installed or fitted in accordance with the manufacturers recommendations.
7. The equipment must be installed or fitted such that good ventilation is not obstructed in any way.
8. The equipment may never be installed in the immediate vicinity of sources of heat, such as parts of heating units, boilers, and other equipment that generates heat (including amplifiers).
9. Connect the equipment to a power supply of the correct voltage, using only the cables recommended by the manufacturer, as specified in the operating instructions and/or shown on the connection side of the equipment.
10. The equipment may only be connected to a legally approved earthed mains power supply.
11. The power cable or power cord must be positioned such that it cannot be walked on in normal use, and objects that might damage the cable or cord cannot be placed on it or against it. Special attention must be paid to the point at which the cable is attached to the equipment and where the cable is connected to the power supply.
12. Ensure that foreign objects and liquids cannot get into the equipment.
13. The equipment must be cleaned using the method recommended by the manufacturer.
14. If the equipment is not being used for a prolonged period, the power cable or power cord should be disconnected from the power supply.
15. In all cases where there is a risk, following an incident, that the equipment could be unsafe, such as:
 - if the power cable or power cord has been damaged
 - if foreign objects or liquids (including water) have entered the equipment
 - if the equipment has suffered a fall or the casing has been damagedif a change in the performance of the equipment is noticed
Appropriately qualified technical staff must check it.
16. The user may not carry out any work on the equipment other than that specified in the operating instructions.

Index

Safety instructions.....	3	Limiter configuration.....	21
Introduction.....	5	Mode.....	21
Installation.....	6	Limiter settings.....	21
Connections.....	6	Certification date.....	21
Signaling connector;	7	Microphone settings.....	21
External display;	8	Sanction settings.....	21
Microphone input.....	8	Multiband.....	22
Audio inputs.....	8	Multiband Limiter.....	22
Audio outputs.....	8	10 band parametric Equalizer.....	22
External attenuator.....	9	Time slots.....	23
Signaling.....	9	Bypass calender.....	23
Operation.....	10	Display.....	24
Technical specifications.....	11	Logging.....	25
Inputs.....	11	Remote access.....	26
Outputs.....	11	Telnet.....	26
Common.....	11	FTP.....	26
Audio.....	11	Owner information.....	27
Limiter.....	11	System settings.....	28
Memory.....	11	IP settings.....	28
External connections.....	11	Language.....	28
Power supply	11	Firmware.....	28
Dimensions and weight.....	11	User settings.....	29
Introduction configuration.....	16	Logging.....	30
Installation.....	17	System status.....	30
Configuration.....	17	Event log	31
Configuration license.....	19	Upload history.....	31
Unlocking the limiter.....	19	Sound sample data.....	32
Automatic installation.....	20	Product support.....	35

Introduction



The SPL6 is an advanced audio level limiter that stores the sound level samples for at least twelve months. The sound level samples can be viewed using the internal web pages or externally stored through automatic email. Other important data is also stored like powering up, sanctions or possible fraud attempts.

Using the web interface the SPL6 can be read out and adjusted. There is no separate platform depended software required. All users can only view settings and logging. To adjust configuration settings an additional password and license file is required. To connect to the SPL6 a computer or tablet must be equipped with a network connection. When connected to a network or the Internet, the SPL6 can be remotely monitored.

The SPL6 uses a measurement microphone to determine the actual sound level. When measurement shows the sound level exceeding the maximum set level, it will reduce slowly the full sound spectrum to the maximum allowed level. In multiband mode the SPL6 will slightly reduce the single frequency band before adjusting the full spectrum.

With the special correlation detection the SPL6 detects external noise pollution and can ignore for example applauding or screaming audience. This way the maximum sound level is always insured.

The special calendar functions allow for different sound levels during the day and year.

Productondersteuning

Voor vragen over de SPL limiter serie, accessoires en andere producten kunt u contact opnemen met:

DATEQ Audio Technologies

De Paal 37
1351 JG Almere
Nederland

Telefoon: 036 – 5472222
E-mail: info@dateq.nl
Internet: www.dateq.nl

Installation

The limiter is installed in between the audio source (a mixing desk for example) and the speaker amplifier.



Image 1: Connecting the SPL6

When calibrating the system, the power amplifier has to be set to maximum output level. The limiter will reduce the signal as much as needed. When used at nominal level the established sound pressure limit will not be exceeded after configuring the limiter. However if in any case this should happen, e.g. When the mixer is used above the nominal level, the limiter will automatically adjust the signal to ensure the sound pressure level remains below the maximum allowed level.

Connections

The SPL6 is equipped with balanced audio in,- and outputs. This type of connection guarantees a solid sound quality, even when long audio cables are used. After the limiter is installed the audio connectors are covered to prevent later adjustments. Removal of this cover will be registered by the SPL6. To re-activate the limiter the key on the front is needed.

Microphone input; XLR 3-pin female

Pin	Function	Description
1	Ground	Audio ground
2	Audio +	Supply and audio
3	Audio -	Supply and audio

Table 1: microphone connections

Audio input left and right; XLR 3-pin female

Pin	Function	Description
1	Ground	Audio ground
2	Audio +	Audio in phase
3	Audio -	Audio out of phase

Table 2: Audio-input connections

Audio outputs left and right; XLR 3-pin male

Pin	Function	Description
1	Ground	Audio ground
2	Audio +	Audio in phase
3	Audio -	Audio out of phase

Table 3: audio-output connections

Signaling connector;
DB-25 female

Pin	Function	In/ output
1	External attenuator	In
2	Reduction signal	Out; 15V/ 5mA max.
3	Overload signal	Out; 15V/ 5mA max.
4	Live OK signal	Out; 15V/ 5mA max.
5	Warning signal	Out; 15V/ 5mA max.
6	Level OK signal	Out; 15V/ 5mA max.
7	Safe level signal	Out; 15V/ 5mA max.
8	External VU unit	In/ Out
9	Microphone +	In
10	Left audio in +	In
11	Right audio in +	In
12	Left audio out +	Out
13	Right audio out +	Out
14...17	Digital ground (to be used with the signaling outputs)	
18...20	Analogue ground (to be used with the audio in and outputs)	
21	Microphone -	In
22	Left audio in -	In
23	Right audio in -	In
24	Left audio out -	Out
25	Right audio out -	Out

Table 4: DB25 connections

USB port; USB-B female

Pin	Function	Description
1	VCC +	Supply
2	Data –	Data
3	Data +	Data
4	GND	Ground

Table 5: USB connections

Network port; RJ45 female

Pin	Function	Description
1	TX-D +	Data
2	TX-D –	Data
3	RX-D +	Data
4		Not in use
5		Not in use
6	RX-D –	Data
7		Not in use
8		Not in use

Table 6: Network connections

External display;
Jack 3-pens female

Pin	Function	Description
SL	Ground	Data ground
Tip	Data TX	Data send
Ring	Data RX	Data receive

Table 7: External display connections

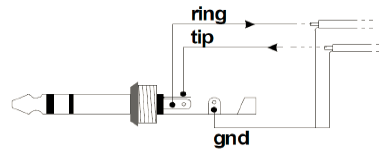

Microphone input

Connect the supplied measuring microphone here. The wiring of the microphone can be lengthened with standard microphone cable. Pay attention to the polarity of the wiring. If the microphone is wrongly connected it won't work. The limiter will give an error message, and the volume will be extremely reduced.

The microphone should be installed so that it 'hears' both sound from the speakers as well as the sound from the crowd in the room. The microphone can be placed closer to the speakers when the maximum allowed level is very low. This reduces the effects of background noises.

Audio inputs

Balanced audio inputs. Pin 1 and 3 of the XLR connector should be linked together when the mixer only has unbalanced outputs. The mixers' signal can be connected to pin 2, and the ground to pin 1.

Audio outputs

Connect the power amplifiers here. Connect pin 2 (signal) and pin 1 (ground) when the power amplifier does not have balanced inputs.

External attenuator

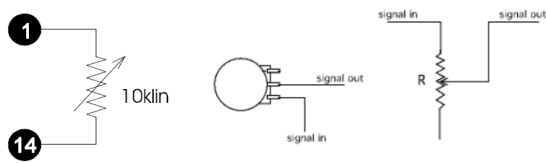

This input can be used to reduce the maximum sound pressure level with an external potentiometer. The maximum sound pressure level can be reduced by connecting a linear 10kOhm potentiometer between pin1 and pin 14.

This can be useful to reduce the sound pressure level from behind the bar. It is also possible to automatically reduce the sound pressure level, for instance when in the summer some doors are opened.

Signaling

Reduction signaling

An indicator to show that the limiter has reduced the sound pressure level can be connected to this output. This output has the same function as the reduction LED on the front of the limiter (Audio reduction).

Overload signaling

This output indicates an overload somewhere in the limiter. This can be the measuring microphone or the audio input. This output has the same function as the overload LED on the front.

Live OK signaling

This output is active as long as the limiter is not in sanction mode. A solid-state relay, to turn off the power supply of the live band, can be connected to this output. If the maximum sound pressure level is exceeded by a band, the limiter will go into sanction mode and cut off the power supply automatically. After a pre-set duration the sanction will be dissolved.

Warning signaling

Level OK

Safe sound pressure

These outputs give an impression of the actual sound pressure level with respect to the maximum allowed level:

- The warning signaling output becomes active, as soon as the maximum sound pressure level is exceeded.
- Level OK indicates that the sound pressure level is below the maximum allowed level, but is getting close (0...12dB span).
- Safe sound pressure indicates that the sound pressure level is well below the maximum allowed limit (12dB or more).

These indicators can be placed near the disc-jockey, or the live band, to give them an impression of the sound pressure level.

External VU unit

This is the data connection with the optional SPL-D2 MKII display. The external display can also directly be connected to the SPL6. For this a stereo 6.3mm jack cable is required.

Operation

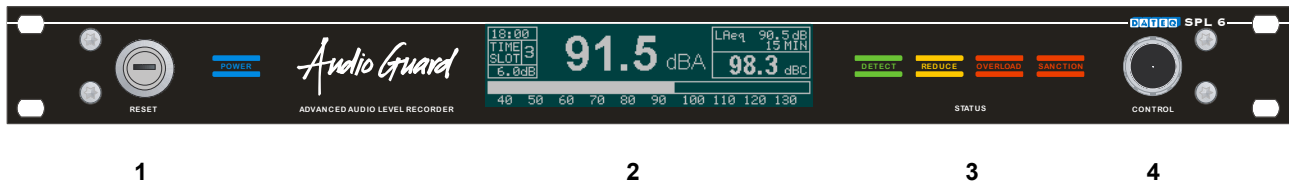

1. Key switch:

After removing the cover lid, the key needs to be set to the blue position to reactivate the limiter. After reactivating the key needs to be returned to the red position. The key switch also resets sanction.

2. Display:

The display shows all important values like system time, current sound level in different values (dBA, dBC, Leq and peak level) and the current reduction. The display can also show the sound level history, sound spectrum, configuration settings and calibration date.

3. Status LED's:

- DETECT LED the SPL6 detected audio signal on the line input (-24dB or more),
- REDUCE LED shows the audio level is above the set maximum. The SPL6 reduces the output level,
- OVERLOAD LED shows an overloaded signal present at the line or microphone input (12dB above threshold level),
- SANCTION LED shows the limiter in sanction state. On fraud detection the limiter will also go into sanction state. The sanction LED will blink. Reset by timer or reset key.

4. Control:

The control knob allows to switch between the different display views. It also allows to select the special test mode, that temporarily reduces the output level. This functionality is specially designed for monitoring agencies.

Technical specifications

Inputs

Mic (Measurement microphone).....	XLR-3 female. Use only the original DCM-5 microphone
Line (left and right).....	XLR-3 female. Electronically balanced.
Maximum input level.....	+18dBu
Input impedance.....	50kOhm
Common-mode rejection.....	>86dB

Outputs

Line (left and right).....	XLR-3 male. Electronically balanced.
Output impedance.....	50Ohm

Common

Audio

Frequency response.....	5Hz...22kHz @ -1dB
Signal/ noise ratio.....	>80dB
THD+N (IEC-A).....	<0.06%

Limiter

Threshold.....	70...120dBA (resolution 1dB)
Output correction.....	-50...+18dB (resolution 0,5dB)
Microphone correction.....	-40...+18dB (resolution 0,5dB)
Maximum attenuation adjustment.....	-6...-50dB (resolution 0,5dB)

Memory

4GB SDHC
365 days * sound pressure information (resolution 1 second)
365 days* event memory
1GB live recording

External connections

External attenuation.....	0...-20dB (10kOhm lin. potentiometer)
Signaling and switching outputs.....	24V/ 5mA max.

Power supply

Supply voltage.....	100...240V _{AC} / 50Hz
Power usage.....	15W

Dimensions and weight

Front.....	483mm x 45mm (B x H) = 19inch/ 1HE
Depth.....	175mm
Weight.....	2.7kg

* Soundlevel data and event logging are stored for maximal 365 days or less when memory is full. The memory system will delete and override oldest data first.

SPL6
MULTIBAND LIMITER
&
SOUND LEVEL RECORDER

Configuration

Notes

Index

Safety instructions.....	3	Limiter configuration.....	21
Introduction.....	5	Mode.....	21
Installation.....	6	Limiter settings.....	21
Connections.....	6	Certification date.....	21
Signaling connector;	7	Microphone settings.....	21
External display;	8	Sanction settings.....	21
Microphone input.....	8	Multiband.....	22
Audio inputs.....	8	Multiband Limiter.....	22
Audio outputs.....	8	10 band parametric Equalizer.....	22
External attenuator.....	9	Time slots.....	23
Signaling.....	9	Bypass calender.....	23
Operation.....	10	Display.....	24
Technical specifications.....	11	Logging.....	25
Inputs.....	11	Remote access.....	26
Outputs.....	11	Telnet.....	26
Common.....	11	FTP.....	26
Audio.....	11	Owner information.....	27
Limiter.....	11	System settings.....	28
Memory.....	11	IP settings.....	28
External connections.....	11	Language.....	28
Power supply	11	Firmware.....	28
Dimensions and weight.....	11	User settings.....	29
Introduction configuration.....	16	Logging.....	30
Installation.....	17	System status.....	30
Configuration.....	17	Event log	31
Configuration license.....	19	Upload history.....	31
Unlocking the limiter.....	19	Sound sample data.....	32
Automatic installation.....	20	Product support.....	35

Introduction configuration



The SPL6 is an advanced audio level limiter that stores the sound level samples for at least twelve months. The sound level samples can be viewed using the internal web pages or externally stored through automatic email. Other important data is also stored like powering up, sanctions or possible fraud attempts.

Using the web interface the SPL6 can be read out and adjusted. There is no separate platform depended software required. All users can only view settings and logging. To adjust configuration settings an additional password and license file is required. TO connect to the SPL6 a computer or tablet must be equipped with a network connection. When connected to a network or the Internet, the SPL6 can be remotely monitored.

The SPL6 uses a measurement microphone to determine the actual sound level. When measurement shows the sound level exceeding the maximum set level, it will reduce slowly the full sound spectrum to the maximum allowed level. In multiband mode the SPL6 will slightly reduce the single frequency band before adjusting the full spectrum.

With the special correlation detection the SPL6 detects external noise pollution and can ignore for example applauding or screaming audience. This way the maximum sound level is always insured.

The special calender functions allow for different sound levels during the day and year.

Installation

The SPL6 configuration pages are tested for use with the following Internet browsers:

- Mozilla Firefox version 36
- Google Chrome version 40

Due to security risks Microsoft Internet Explorer is not supported.

Configuration

In this chapter the configuration and system settings for the SPL6 are explained. These settings normally are made once on installation. All made settings can be stored in a backup file for later use or restoring the original settings after changing.

Connecting the computer

The computer is connected to the limiter using an UTP cable. The limiter can also be integrated into an existing network. Connect the ethernet plug into the network.

Directly connected to the computer, a straight or cross wire cable can be connected.

When using a direct cable connection the computers IP address needs to be manually changed. Make sure the computer is assigned to the same IP range.

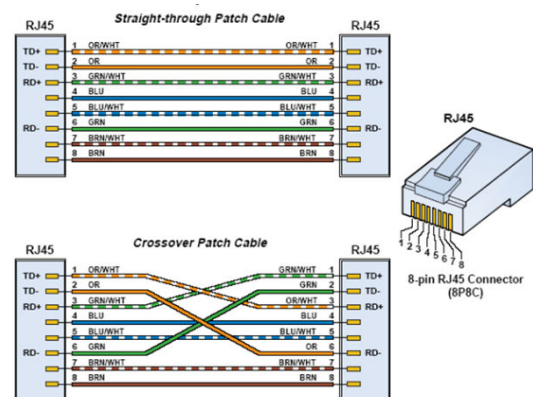
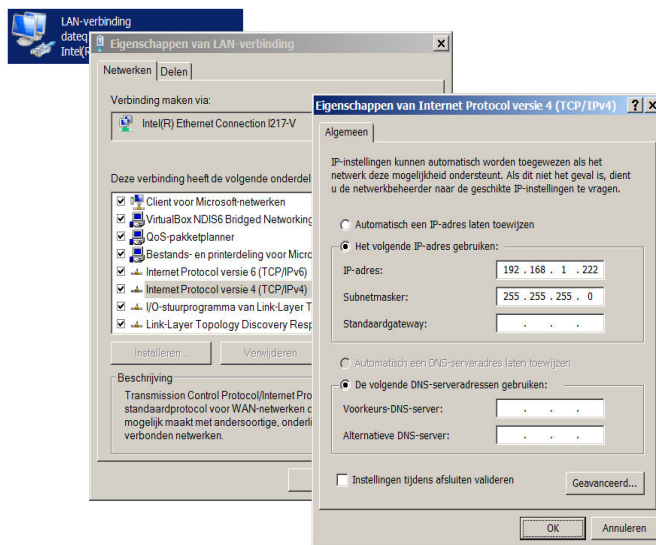

The limiter can now be accessed using: <http://spl6/> or by entering the default IP address: <http://192.168.1.101/>. When not using the default IP address, like in a custom network environment, the IP address can be viewed in the settings view on the front panel display.

Example settings to connect the SPL6 to the internet

The following images show how a router is set to redirect the connections from the internet to the SPL6. The exact settings depend on the brand and type of the router.

Allowing external access from the internet is often called as 'Virtual servers', 'Port forwarding' or 'Port redirection'.

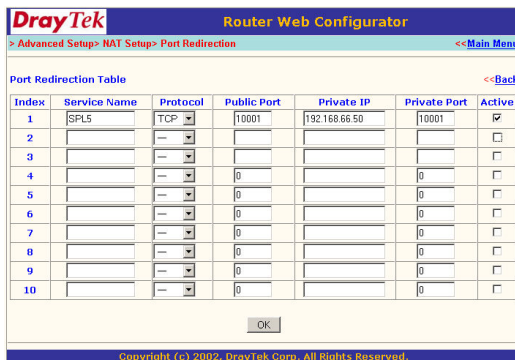
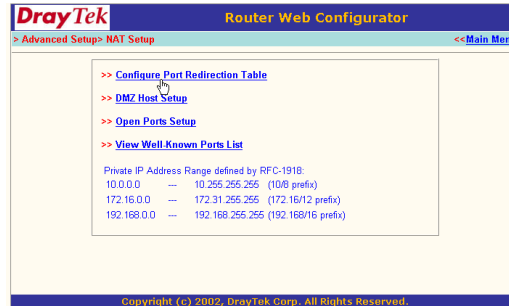
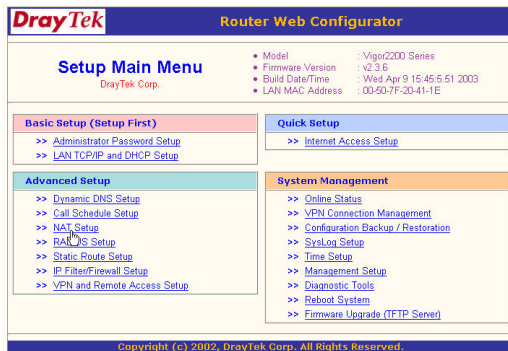

- Open the router configuration page
- Select the 'NAT setup' page
- Select 'Port redirection'
- Now set the IP address for the SPL6, the external port number and the local port number.

The following ports are used:

Http: port 80
FTP: port 21
Telnet: port 23

Important:

- Always ask your system administrators' permission to make these type of adjustments. If you doubt, or are not familiar with network settings, ask your network administrator for assistance!
- Some internet service providers do not allow their clients to add servers to the internet. Please check your contract or inform with your ISP.
- Your connection to the internet needs to have a static IP address to make the SPL6 available over the internet. Some providers use dynamic IP addresses. This means your IP address can change after some time. This makes it impossible to connect to the SPL6.
- Opening a port to the internet is always a security risk, therefore check for updates regularly, and do not make the limiter available on the internet is not really needed.

Configuration license

The configuration pages are commonly only used to view settings and sound sample logging. For viewing or exporting no license or password is needed. Changing settings, including first installation an installer license and password is needed.

The installer license is only granted to certified professional audio installers. When you own an SPL limiter and settings need to be changed, you need to contact your local distributor or installer. The closest supplier can be found at the Dateq selling points part of the website: www.dateq.nl.

Installer

Name: Dateq B.V.
Contact: Service desk
Street: De Paal 37
Zipcode: NL-1351JG
City: Almere
Country: Netherlands
Tel.: +31-36-5472222
Fax.: --
Website: www.dateq.nl
Email: info@dateq.nl
Remark: service license

An installer license is linked and registered to the installing company and can not be transferred to third parties. The installer license contains all company and contact details, that will be stored into the SPL limiter during configuration.

Unlocking the limiter

Before changes can be made the license password must be entered. This password is linked and stored within the license file. When accessing the limiter through the internet an extra user name and password can be needed. The internet user name and password are handled in the remote access section.

Upload license

Password:

Unlock

Only after correctly entering the internet user name, password, uploading the license file and entering the license password, configuration changes can be made.

Automatic installation

Through the automatic installation process the basic sound level settings for the SPL6 can be made. On starting the installation the different popup windows will guide the installation. Make sure popup blockers in your browser are disabled before starting.

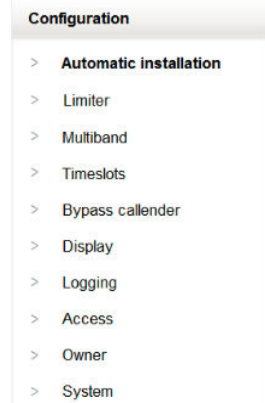
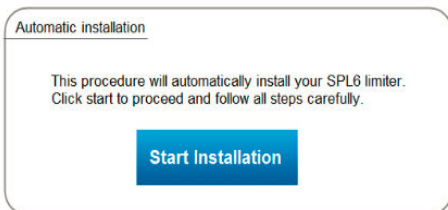

The limiter will automatically set all audio values during the installation process. Before starting the complete audio system must be connected and powered on. It is best to use an audio-source with less dynamics to perform the installation; this makes it easier for the computer to calculate the levels. Select the menu-item 'Automatic install'. The software will perform a step-by-step installation:

- Set the output-level to nominal. This means that all the green LEDs on the VU-meter light up, and every now and then some red light will blink,
- Set the output level of the amplifiers to the maximum,
- Enter the maximum dB values,
- The limiter will adjust the output-volume, until the requested sound level is acquired. In the meantime read the sound level at the level-meter in the room,
- After some time the actual audio-level in the room will be asked. This is to compensate the microphone offset value.

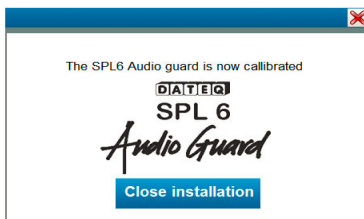

The limiter is now calibrated. Check the settings by raising the volume of the mixer till the 'REDUCE' LED on the front panel lights up. The limiter will automatically lower the volume. All the settings can be changed manually, if necessary.

Limiter configuration

The manual configuration of sound level parameters.

Mode

- Live Limiter and recorder
- Line Limiter and recorder

In Live mode the limiter will reduce the output level on microphone measurement. The microphone actively influences the output level.

In Line mode the limiter only acts on the line level input. The microphone is used for audio level recording only.

Limiter settings

- Maximum dBA: 50dB tot 125dB.
- Maximum dBC: 50dB tot 125dB.
- Maximum peak: 50dB tot 125dB.
- Input threshold: -50dB tot +18dB.
- Output attenuation: -60dB tot 0dB.
- Maximum reduction: 60dB tot 0dB.

Certification date

The certification date is set to enable future inspection. Till the certification date the limiter will function as normal. On passing the selected date the limiter will reduce the output signal with an extra 18dB and display the 'certification invalid' message on the front panel display.

The limiter can only be unlocked and reset by a certified installer.

Microphone settings

- Microphone correction: -30dB till +12dB.
- Microphone distance: 0 till 30 meter.

Sanction settings

- Time till sanction: 10 tot 360 seconds.
- Sanction time: 10 tot 360 seconds.
- As soon as overload will become active, the sanction timer will start running.
- When overload becomes inactive, the sanction timer will decrees each counted second.

Configuration

- > Automatic installation
- > **Limiter**
- > Multiband
- > Timeslots
- > Bypass callender
- > Display
- > Logging
- > Access
- > Owner
- > System

<p>Limiter mode</p> <p>Mode: Live limiter and recorder</p>	
<p>Limiter settings</p> <p>Maximum level dBA: <input type="text" value="74"/> dB <input type="checkbox"/> Enable</p> <p>Maximum level dBC: <input type="text" value="95"/> dB <input type="checkbox"/></p> <p>Maximum peak level: <input type="text" value="95"/> dB <input type="checkbox"/></p> <p>Input threshold: <input type="text" value="0"/> dB</p> <p>Output attenuation: <input type="text" value="0"/> dB</p> <p>Maximum reduction: <input type="text" value="30"/> dB</p>	<p>Microphone settings</p> <p>Microphone correction: <input type="text" value="0"/> dB</p> <p>Microphone distance: <input type="text" value="4"/> M</p> <p>Microphone delay: <input type="text" value="12"/> mS</p> <p>Microphone sensitivity: <input type="text" value="3.4"/> mV</p> <p>Correlation detection: <input type="checkbox"/></p>
<p>Certification date</p> <p>Certification until: <input type="text"/> <input type="checkbox"/> Enable</p>	<p>Sanction settings</p> <p>Time till sanction: <input type="text" value="20"/> S <input type="checkbox"/> Enable</p> <p>Sanction time: <input type="text" value="15"/> S</p>

Note; Changes are effective immediately.

Multiband

Here the settings for the multiband (octave) limiter and parametric equalizer are made. All settings are immediately active.

Multiband Limiter

The multiband limiter will act as an octave limiter before the complete audio level is reduced. Set the maximum allowed band reduction and enable the limiter to activate it. Using the multiband limiter a higher sound level output efficiency can be made without overshooting the maximum allowed dB values.

Each octave limiter can maximal reduce the octave band by 12dB before the general output reduction becomes active.

- Configuration**
- > Automatic installation
 - > Limiter
 - > **Multiband**
 - > Timeslots
 - > Bypass caller
 - > Display
 - > Logging
 - > Access
 - > Owner
 - > System

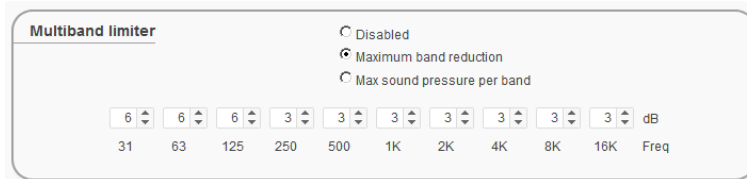

The multiband limiter can also be set to use the actual SPL dB values per band making sure the SPL level on that specific band does not exceed the maximum set level.

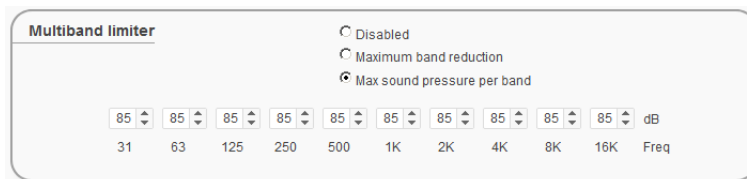

10 band parametric Equalizer

Using the 10 band parametric equalizer a speaker correction can be made. Disturbing frequencies can be corrected by 12dB. The equalizer settings do not affect the multiband limiter.

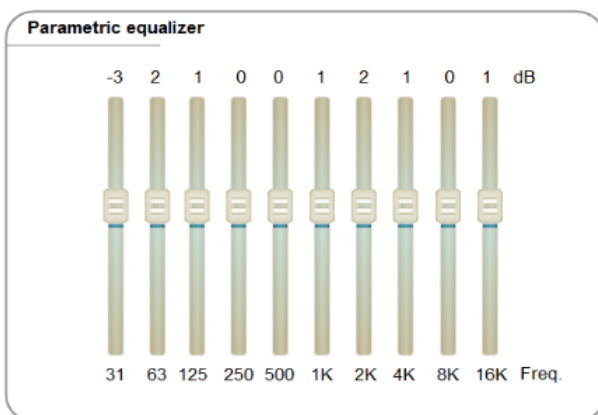

Time slots

The time slots allow different dB values during the week. Three slot's a day are available. The slot reduces the maximum allowed value by the selected amount of dB.

Settings become active after storing.

- Configuration**
- > Automatic installation
 - > Limiter
 - > Multiband
 - > **Timeslots**
 - > Bypass callender
 - > Display
 - > Logging
 - > Access
 - > Owner
 - > System

Timeslots	Timeslot 1	dB	Timeslot 2	dB	Timeslot 3	dB	Copy
Sunday	07 Hrs 00 Min	0	19 Hrs 00 Min	-5	23 Hrs 00 Min	-10	-- Copy From --
Monday	07 Hrs 00 Min	0	19 Hrs 00 Min	-5	23 Hrs 00 Min	-10	-- Copy From --
Tuesday	07 Hrs 00 Min	0	19 Hrs 00 Min	-5	23 Hrs 00 Min	-10	-- Copy From --
Wednesday	07 Hrs 00 Min	0	19 Hrs 00 Min	-5	23 Hrs 00 Min	-10	-- Copy From --
Thursday	07 Hrs 00 Min	0	19 Hrs 00 Min	-5	23 Hrs 00 Min	-10	-- Copy From --
Friday	07 Hrs 00 Min	0	19 Hrs 00 Min	-5	23 Hrs 00 Min	-10	-- Copy From --
Saturday	07 Hrs 00 Min	0	19 Hrs 00 Min	-5	23 Hrs 00 Min	-10	-- Copy From --

The internal clock will automatically synchronize to the internet time protocol (NTP). When not connected to the internet, the time and date can be set manually.

Time sync settings

NTP
 Manual

Use DST

GMT+1 Amsterdam, Berlin, Rome

Date and time

februari 2015

ma	di	wo	do	vr	za	zo
26	27	28	29	30	31	1
2	3	4	5	6	7	8
9	10	11	12	13	14	15
16	17	18	19	20	21	22
23	24	25	26	27	28	1
2	3	4	5	6	7	8



14:52:29

Bypass calender

The bypass calender allows to set different times and dates to disable the limiter. The input signal will not be reduced during a bypass slot. The equalizer settings stay active during bypass.

A total of 20 independent bypass slots can be set.

- Configuration**
- > Automatic installation
 - > Limiter
 - > Multiband
 - > Timeslots
 - > **Bypass calender**
 - > Display
 - > Logging
 - > Access
 - > Owner
 - > System

Enable	Name	Enable	Name
<input checked="" type="checkbox"/>	Koningsdag	<input checked="" type="checkbox"/>	
<input checked="" type="checkbox"/>		<input checked="" type="checkbox"/>	
<input checked="" type="checkbox"/>		<input checked="" type="checkbox"/>	
<input checked="" type="checkbox"/>		<input checked="" type="checkbox"/>	
<input checked="" type="checkbox"/>		<input checked="" type="checkbox"/>	
<input checked="" type="checkbox"/>		<input checked="" type="checkbox"/>	
<input checked="" type="checkbox"/>		<input checked="" type="checkbox"/>	
<input checked="" type="checkbox"/>		<input checked="" type="checkbox"/>	
<input checked="" type="checkbox"/>		<input checked="" type="checkbox"/>	
<input checked="" type="checkbox"/>		<input checked="" type="checkbox"/>	

Koningsdag

Date	Time
Start at 30-04-2015	18:00
End at 01-05-2015	06:00

Yearly repeat

Display

The front panel display allows to view different values.

Large:

- dB(A) (standard)
- dB(C)
- Leq-1
- Leq-2
- dB peak

Small:

- dB(A)
 - dB(C) (standard)
 - Leq-1
 - Leq-2
 - dB Peak
- Leq:

Leq:

- Leq-1 (standard)
- Leq-2

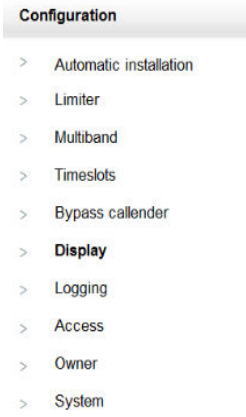
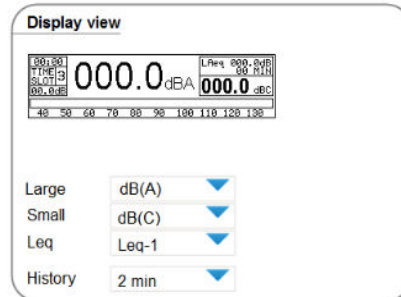

The bottom VU meter always shows fast VU.
 Integrated fast VU: 0.125 seconds, Integrated slow VU: 1 second.

History screen: 2 till 60 minutes, standard 2 minutes. Screen divided into 120 markers.

Leq value 1:

Maximum: 50 tot 125dB, standard 85

Leq filter: A of C, standard A

Leq calculation: 1 tot 360 seconds and 1 tot 60 minutes, standard 2 minutes.

Enable: standard on

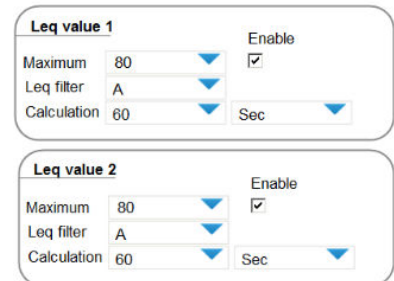

Leq value 2:

Maximum: 50 tot 125dB, standard 85

Leq filter: A of C, standard C

Leq calculation: 1 tot 360 seconds en 1 tot 60 minutes, standard 15 minutes

Enable: standard off

Leq-1 en 2 automatically change name in all views to the selected time and filter weight.
 For example: Laeq2m or Lceq15m.

External Display:

Type: Off, SPL-D2 MK2, standard SPL-D2 MK2

Show: dB(A), dB(C), dB, Leq-1, Leq-2, standard dB(A)

Bar: fast VU, slow VU, reduction, standard fast VU.

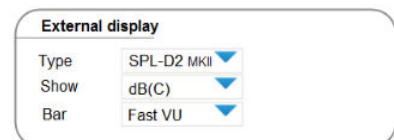

SPL-D2 optional external display:



Logging

The SPL6 records all measured values into PDF and CSV file format. An independent file is generated for each day. Select the values that need to be implemented. By default all values are available.

Data not selected for the file reports stays available within the SPL6. Exception on the storage are the overload sound samples. These are local privacy regulation dependent.

The SPL6 stores measured values for each second. This way an historic record can be viewed at each point in time.

Save in logging

- dB(A)
- dB(C)
- Peak
- Leq-1
- Leq-2
- Line input level
- Correlation detection
- Errors and protection items
- Overload sound sample (*)

(*) Depends on local regulations

Configuration

- > Automatic installation
- > Limiter
- > Multiband
- > Timeslots
- > Bypass caller
- > Display
- > **Logging**
- > Access
- > Owner
- > System

Reports are generated on the selected interval day or weekly. The reports are send out by FTP or email to an external server. Contact your local network administrator for the server details. After setting the server details the SPL6 will send out all day reports. These reports contain all selected information from the past full day or days.

When no connection to the servers can be made an error message will be stored. The SPL6 will not try to resend but add the not send reports to next planned.

Storage Remote storage

Interval: Weekly

Day: Monday 12:00

File format: CVS

FTP server:

Username:

Password:

Email Email report

Interval: Weekly

Day: Monday 12:00

File format: CVS

Email address:

SMTP server:

Password:

Remote access

By default the SPL6 can only be reached within the local LAN network. The SPL6 automatically recognizes whether it is contacted through the local LAN or through the Internet. To enable remote internet control and readout, 'Allow internet access' must be enabled.

Telnet

For advanced users telnet control is made possible. Telnet access is used on the standard TCP port 23.

Using the telnet connection an external server can remotely view the current limiter status. Adjusting the limiter configuration through telnet is not possible. The telnet command list is available on request only.

FTP

The internal FTP server allows to access the internal logging and sound level reports. These reports are read only and can't be adjusted or deleted. FTP access is made possible using the standard TCP port 21. By default this functionality has been disabled.

Internet access to telnet or FTP is only possible when 'Allow internet access' has been enabled. The internet access user and password do not apply to FTP and telnet connections.

Configuration

- > Automatic installation
- > Limiter
- > Multiband
- > Timeslots
- > Bypass callender
- > Display
- > Logging
- > **Access**
- > Owner
- > System

Remote access

Allow internet access

Username

Password

Allow telnet access

Username

Password

Allow FTP access

Username

Password

Owner information

The SPL6 will display the owner information in several reports and logging. To ensure the information is correctly displayed, it must be filled in as complete as possible.

Owner information

Company	<input type="text"/>
Contact	<input type="text"/>
Title	<input type="text"/>
Street	<input type="text"/>
Zip code	<input type="text"/>
Place	<input type="text"/>
Country	<input type="text"/>
Telephone	<input type="text"/>
Website	<input type="text"/>
Email	<input type="text"/>

[Update information](#)

Hoofdmenu

- > Automatic installation
- > Limiter
- > Multiband
- > Timeslots
- > Bypass caller
- > Display
- > Logging
- > Access
- > **Owner**
- > System

System settings

Below the SPL6 device settings are made.

IP settings

Enter the SPL6 IP address. By default it is set to 192.168.1.101.
Contact you local system administrator before adjusting.

Network_settings

DHCP

Name

IP_address

Subnet

Gateway

DNS

Configuration

- > Automatic installation
- > Limiter
- > Multiband
- > Timeslots
- > Bypass caller
- > Display
- > Logging
- > Access
- > Owner
- > **System**

Language

The SPL6 can be set to four languages.

- English
- Dutch
- French
- German

Taal

Taal

[Restart](#)

The language will be applied trough out the complete device.
When adjusting the system language the SPL6 will reload it's webpage.

Firmware

Select the new firmware through upload & update.
When connected to the internet the SPL6 can automatically download the latest firmware from the Dateq servers. To update click online update.

Firmware

Version V2.44_beta

File [Upload_update](#)

Online_available V2.45_stable [Online_update](#)

A complete backup of all settings will be made before updating the latest firmware. After updating the SPL6 will automatically restore all previous settings.

!! Important

Never switch off the SPL6 during the update process! This can damage the SPL6 beyond repair.

User settings

All user settings can be stored to a backup file on your computer. This backup file can be restored to any SPL6 device. The SPL6 can also be restored into factory default.

!!

When restoring the SPL6 into factory default all settings, reports and log files are erased.

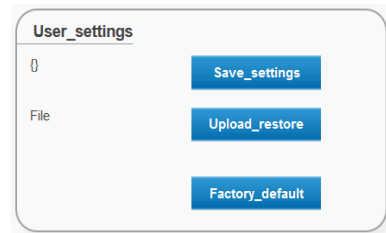

The 'User_settings' interface features a header 'User_settings' and a 'File' label. It contains three blue buttons: 'Save_settings', 'Upload_restore', and 'Factory_default'.

Device information

Displays the factory information of the device.

Factory calibration displays the last factory calibration and calibration code.

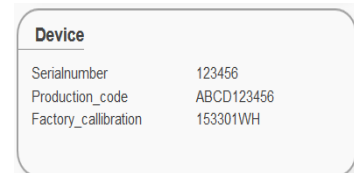

Device	
Serialnumber	123456
Production_code	ABCD123456
Factory_calibration	153301WH

Logging

The SPL6 is equipped with an advanced logging and recording system. This system stores all system events, sound samples and optional records overload sound samples into it's memory. All system logging can automatically be send by email or remotely be stored through FTP.

Within the logging tab all statuses are displayed and can be exported or stored.

Logging

- > **System_status**
- > Event_log
- > Upload_history
- > Sound_sample_data

System status

The system status displays the current limiter status.

- Current measured line signal
- Current core and memory status
- Current reduction and multiband reduction



Event log

The event log shows all system events from the selected date.



Logging

- > System status
- > **Event log**
- > Upload history
- > Sound sample_data

Upload history

The upload history shows all historic system and limiter settings changes. It allows to view when which installer made what limiter changes.

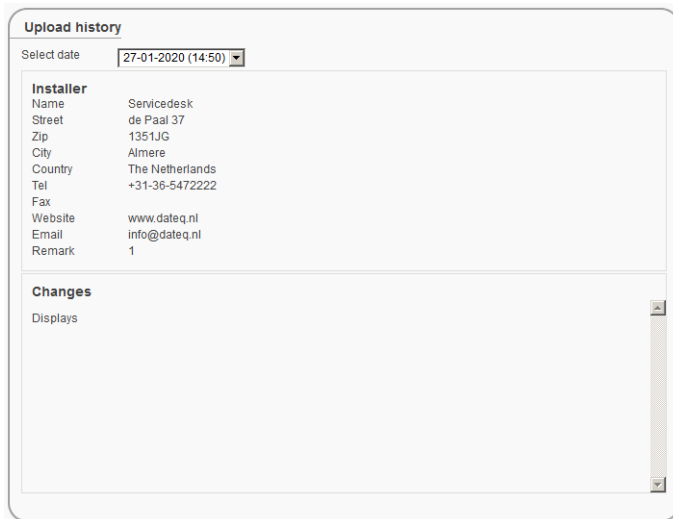

Logging

- > System status
- > Event log
- > **Upload history**
- > Sound sample data

Sound sample data

The SPL6 stores all selected sound sample data into the internal memory. Sound sample data can be read back for at least 12 months.

Select a date and time window to view the recorded samples.

Select date Start End

Select the desired measurement value.

View

- dB(A) Timeslot
- dB(C) Line_input_level}
- Peak Errors and protection items
- Leq-1 Correlation detection
- Leq-2 Overload sound sample

Logging

- > System status
- > Event log
- > Upload history
- > **Sound sample data**

All sound samples can be exported and stored to CSV for further analysis or legal evidence.

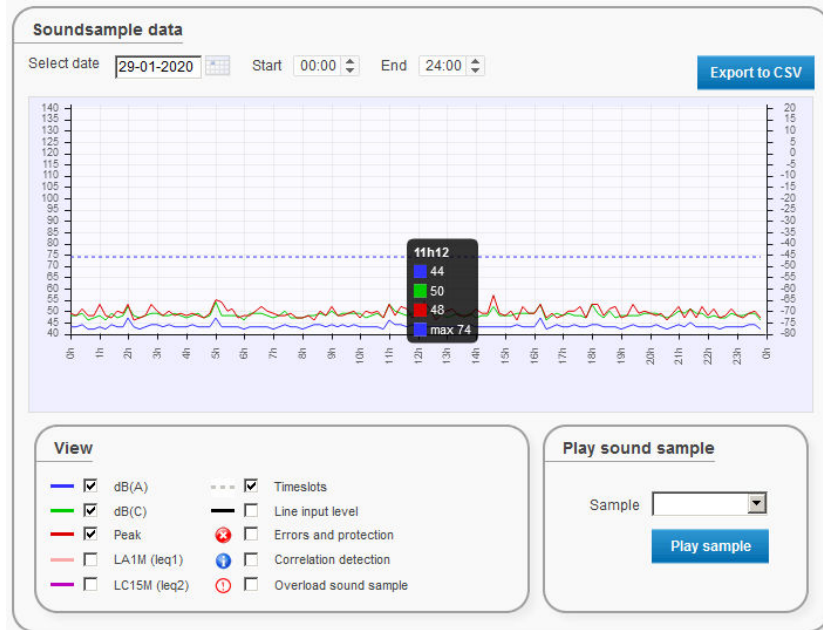

To view the exact measured data point the mouse onto the graphics. The graphic will show a small popup containing the selected measurement values.

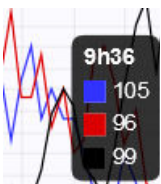

When selected within the logging configuration overload sound sample WAV files can be played. The WAV files will be stored over a maximum period of 12 months, deleting the oldest files first.



Certificate of calibration

Calibrated equipment details

Instrument manufacturer: Dateq B.V.
 Instrument type: SPL-6
 Description: Sound level limiter and recorder

Serial number: _____

Production code: _____

Calibration code: _____

Calibration procedure

The instrument with above serial number has been calibrated using techniques were applicable for calibration procedures as described in the latest revision of International standards: IEC61672-1 - IEC61672-2 - IEC60651 - IEC60804 - IEC61260 - IEC60942 - IEC61252 - ANSIS1.4 - ANSIS1.11 - ANSIS1.43- AFNOR class 2a and 2b NFS 31-122 - décret 98-1143 and DIN45680_1997. All calibration procedures were carried out by substituting the microphone capsule with a suitable electrical generated acoustical signal, apart from the electric line level signal.

Calibration standard

The instrument with above serial number detailed in this document was calibrated to match the calibration and testing laboratory standard and design specifications as used by Dateq B.V.

Calibration equipment:	
Audio line signal source:	Audio precision portable one plus
Audio microphone signal source:	Audio precision portable one plus
Audio microphone signal source:	Brüel & Kjær sound level calibrator Type: 4230 sn:1102808
Audio microphone signal reference:	Brüel & Kjær Class 1 sound level meter Type: 2232 sn:1777899
Microphone type:	Dateq DCM-5
Microphone reference type:	Brüel & Kjær Class 1 measurement microphone Type: 4176 sn:1770346

Calibrated by: _____

Calibration date: Friday, 28 August 2015
 Certification: 2:05:39 PM

This calibration certification is valid for 12 months from the date above.

Calibration certification was granted in laboratory setup. Installed devices may need independent manual recalibration depending on local environment, microphone placement or local law. This certificate may be used for reference purposes only.



DECLARATION OF CONFORMITY

acc.to art.10.1 EMC directive 89/336/EEC

We, **DATEQ Audio Technologies B.V.**
de Paal 37
1351 JG ALMERE
THE NETHERLANDS

hereby declare, exclusively to our responsibility, that this product

Type: SPL 6 SerialInrs.: 67-XXXX

to which this declaration applies, is in accordance with the following
harmonized European norms

EN 50081-1 and EN 50082-1

According to the regulations of the EMC-directive 89/336/EEG, amended by
directive 91/263/EEG, 92/31/EEG and 93/68/EEG.

EN 60065

According to the regulations of IEC 65: 1985 + A1: 1987 + A2: 1989 + A3:
1992, mod. Ratification: 1993-07-06

Almere, August 25th 2015

Managing director

stamp:

signature:

DATEQ
audio technologies
De Paal 37
1361 JG Almere
tel. 036-5472222, fax 036-5317776

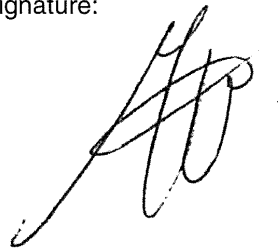

Product support

For questions about the SPL series limiters, accessories or other products contact Dateq at:

Dateq Audio Technologies B.V.

De Paal 37
1351 JG Almere
The Netherlands

Phone: (036) 54 72 222
E-mail: info@dateq.nl
Internet: www.dateq.nl