



## INSTALLATION AND OPERATION MANUAL

# WPBT

*Bluetooth Audio Receiver*



# IMPORTANT SAFETY INFORMATION



1. READ these instructions.
2. Keep these instructions.
3. Heed all warnings.
4. Follow all instructions.
5. Do not use this apparatus near water.
6. Clean only with dry cloth.
7. Do not block any ventilation openings. Install in accordance with the manufacturer's instructions.
8. Do not install near any heat sources such as radiators, heat registers, stoves, or other apparatus (including amplifiers) that produce heat.
9. Do not defeat the safety purpose of the polarized or grounding-type plug. A polarized plug has two blades with one wider than the other. A grounding type plug has two blades and a third grounding prong. The wide blade or the third prong are provided for your safety. If the provided plug does not fit into your outlet, consult an electrician for replacement of the obsolete outlet.
10. Protect the power cord from being walked on or pinched particularly at plugs, convenience receptacles, and the point where they exit from the apparatus.
11. Only use attachments/accessories specified by the manufacturer.
12. Use only with the cart, stand, tripod, bracket, or table specified by the manufacturer, or sold with the apparatus. When a cart is used, use caution when moving the cart/apparatus combination to avoid injury from tip-over.
13. Unplug this apparatus during lightning storms or when unused for long periods of time.
14. Refer all servicing to qualified service personnel. Servicing is required when the apparatus has been damaged in any way, such as power-supply cord or plug is damaged, liquid has been spilled or objects have fallen into the apparatus, the apparatus has been exposed to rain or moisture, does not operate normally, or has been dropped.
15. This appliance shall not be exposed to dripping or splashing water and that no object filled with liquid such as vases shall be placed on the apparatus.
16. Plug this apparatus to the proper wall outlet and make the plug to be disconnected readily operable.
17. Mains plug is used as disconnected device and it should remain readily operable during intended use. In order to disconnect the apparatus from the mains completely, the mains plug should be disconnected from the mains socket outlet completely.
18. WARNING: To reduce the risk of fire or electric shock, do not expose this apparatus to rain or moisture.
19. An appliance with a protective earth terminal should be connected to a mains outlet with a protective earth connection.
20. The apparatus should be disconnected from the mains completely before speaker wiring. The speaker output should be proper protected from direct contact and pay attention to speaker connections, terminals and speaker wiring during normal operation.

# PRÉCAUTIONS DURANT UTILISATION

1. LISEZ ces instructions.
2. Tenez ces instructions.
3. Notez tous les avertissements.
4. Suivez toutes les avertissements.
5. N'utilisez pas ce produit près de l'eau (la piscine, la plage, le lac, etc.).
6. Nettoyez seulement avec une étoffe sèche.
7. Ne bloquez aucuns trous de ventilation. Installez en accord avec les instructions du manufacturier.
8. N'installez près aucunes sources de chaleur comme radiateurs, registres de chaleur, fours ou les autres équipements (y compris amplificateurs) qui produisent la chaleur.
9. Ne défaites pas le but de sécurité de la fiche polarisée ou base-type. Une fiche polarisée a deux tranchants avec un plus large que l'autre. Une fiche de base type a deux a deux tranchants et une troisième pointe de base, le tranchant large ou la troisième pointe est fourni pour votre sécurité. Si la fiche donnée ne conforme pas votre prise de contact, consultez un électricien pour remplacement de la prise de contact obsolète.
10. Protégez le cordon de secteur contre être marché dessus ou pincez en particulier aux fiches, aux douilles de convenance, et au point où ils sortent de l'appareil.
11. Seulement utilisez attachements/accessoires spécifiés par le manufacturier.
12. Utilisez seulement avec un chariot, un stand, un trépied, un support ou une table indiquée par le manufacturier, ou vendue avec l'appareil. Quand un chariot est utilisé, faites attention en déplaçant la combinaison d'appareil/chariot pour éviter de se déséquilibrer.
13. Arrachez la fiche du dispositif durant éclair et orage ou quand pas utilisé pour longues périodes de temps.
14. Référez au personnel qualifié de service pour toutes réparations. La réparation est donnée quand le système a été endommagé à n'importe façon, par exemple un fil ou une fiche endommagé(e) de la source d'alimentation. Avoir été exposé à pluie ou humidité, n'opère pas normalement, ou avoir été tombé.
15. L'appareil ne doit pas être exposé aux écoulements ou aux éclaboussures et aucun objet ne contenant de liquide, tel qu'un vase, ne doit être placé sur l'objet.
16. Branchez l'appareil à une source appropriée et faire que la prise à débrancher soit facilement accessible.
17. La prise du secteur ne doit pas être obstruée ou doit être facilement accessible pendant son utilisation. Pour être complètement déconnecté de l'alimentation d'entrée, la prise doit être débranchée du secteur.
18. AVERTISSEMENT: Pour éviter le risque d'incendie ou de chocs électriques, ne pas exposer cet appareil à la pluie ou à l'humidité.
19. Un appareil avec la borne de terre de protection doit être connecté au secteur avec la connexion de terre de protection.
20. Assurez-vous que l'appareil est hors tension avant de connecter les hauts parleurs. Vérifiez que la sortie des enceintes soit protégées contre un contact physique. Respecter les polarités des terminaux ainsi que le câblage des enceintes pendant le fonctionnement afin d'assurer une utilisation sécurisée.

# INTRODUCTION & CONTENTS



## WPBT

The Australian Monitor WPBT audio receiver is a programmable Bluetooth® audio receiver wall panel. Featuring front panel media controls, pairing and source selector buttons as well as a 3.5mm auxiliary input for wired devices.

The WPBT can be programmed using free downloadable Bluetooth Control software to modify the broadcast name, PIN number and various security features.

Features	4
Block Diagram	4
Front Panel	5
Bluetooth control Software	6
WPBT Wiring	7
WP-BREAKOUT Accessory	8
WP-BREAKOUT Wiring	8
Dimensions	9
Specifications	10

Revision 1.1: August 2022

### WARNING

TO PREVENT FIRE OR SHOCK HAZARD, DO NOT USE THE PLUG WITH AN EXTENSION CORD, RECEPTACLE OR OTHER OUTLET UNLESS THE BLADES CAN BE FULLY INSERTED TO PREVENT BLADE EXPOSURE.

TO REDUCE THE RISK OF FIRE OR ELECTRIC SHOCK, DO NOT EXPOSE THIS APPLIANCE TO RAIN OR MOISTURE.

TO PREVENT ELECTRICAL SHOCK, MATCH WIDE BLADE PLUG TO WIDE SLOT & FULLY INSERT.

### CAUTION

TO REDUCE THE RISK OF ELECTRIC SHOCK DO NOT PERFORM ANY SERVICING OTHER THAN THAT CONTAINED IN THE OPERATING INSTRUCTIONS UNLESS YOU ARE QUALIFIED TO DO SO.



The lightning flash with arrowhead symbol, within an equilateral triangle, is intended to alert the user to the presence of uninsulated "dangerous voltage" within the product's enclosure that may be of sufficient magnitude to constitute a risk of electric shock to persons.

#### CAUTION

**RISK OF ELECTRIC SHOCK  
DO NOT OPEN**

#### WARNING

TO REDUCE THE RISK OF ELECTRIC SHOCK, DO NOT REMOVE COVER (OR BACK). NO USER SERVICEABLE PARTS INSIDE. REFER SERVICING TO QUALIFIED SERVICE PERSONNEL.



The exclamation point within an equilateral triangle is intended to alert the user to the presence of important operating and maintenance (servicing) instructions in the literature accompanying the appliance.



For European Union countries: This symbol on the product or its packaging indicates that this product must not be disposed of with other waste. Instead, it is your responsibility to dispose of your waste equipment by handing it over to a designated collection point for the recycling of waste electrical and electronic equipment. Please contact your local authority for further details of your nearest designated collection point.

# FEATURES

- Bluetooth v5.1 audio receiver
- Supported Bluetooth profiles
  - A2DP Sink – Advanced audio distribution profile
  - AVRCP – Audio/Video remote controller profile
  - HFP Sink - Hands free profile
- Front Panel
  - 3.5mm auxiliary input
  - Bluetooth media controls
  - Pairing button
  - Source selector button
- Rear panel
  - Balanced audio output. Stereo or mono mode
  - USB-C programming connector
  - RS485 Comms Port

# BLOCK DIAGRAM

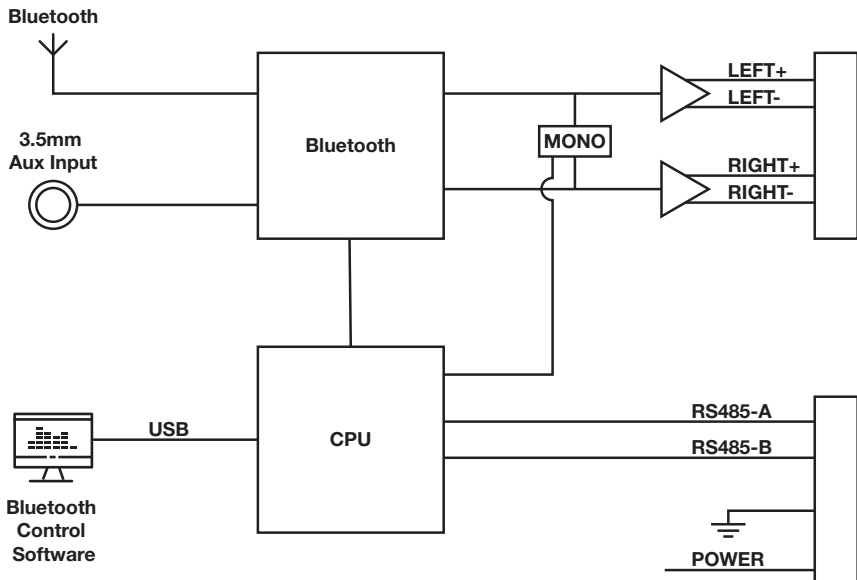

# FRONT PANEL

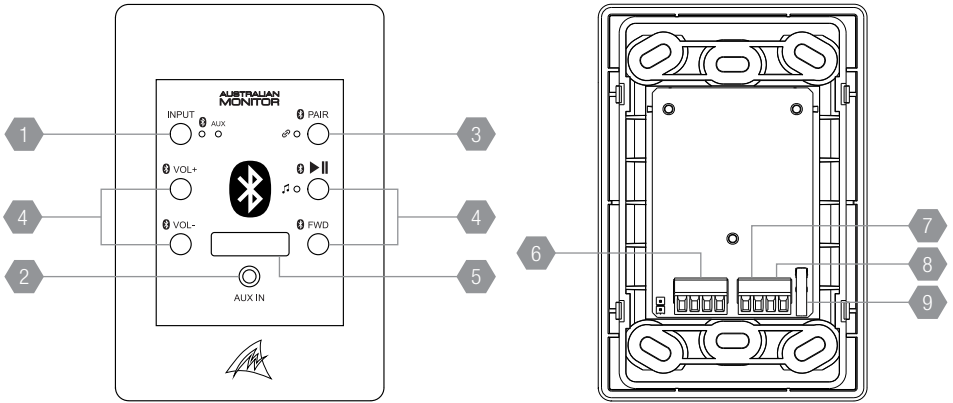

- 1 INPUT SELECTOR**  
Switches the audio input between the Bluetooth receiver and the 3.5mm auxiliary input.
- 2 3.5MM AUXILIARY INPUT**  
A stereo 3.5mm line level auxiliary input. Connect wired devices to this connector and select the AUX input on the source selector button.
- 3 PAIRING BUTTON**  
Press until the LED starts flashing which indicates pairing mode entered. When the device pairs to the WPBT the PAIR LED will stay on. If no device pairs, and the pairing timeout is exceeded, the LED will turn off and the device will enter a non-discoverable state. (If required, the timeout can be disabled in software).
- 4 BLUETOOTH MEDIA CONTROLS**  
These buttons will send commands to the paired device, e.g. a mobile phone, to modify volume, play/pause or skip tracks.

**⚠ NOTE:** It does NOT provide any controls for the 3.5mm auxiliary input.  
**NOTE:** Some devices disable volume syncing. Consult your device manual how to enable volume sync.

- 5 BROADCAST NAME LABEL**  
The Bluetooth broadcast name should be applied here. It informs end users the name of the device they should connect to from their remote device.
- 6 BALANCED AUDIO OUTPUTS**  
Stereo balanced 3.81mm euroblock outputs. If mono output is required, it can be configured using the Bluetooth control software via the USB-C connector. Mono is outputted on both LEFT and RIGHT.
- 7 RS485**  
Unused in standalone operation. This is used for connection to compatible Australian Monitor products for direct control of the WPBT without requiring the Bluetooth Control Software programming. E.g. The ZONEMIX system.
- 8 POWER INPUT**  
Accepts +15VDC (50mA) to +24VDC(60mA) input.
- 9 USB-C CONNECTOR**  
Used to program the WPBT via the PC control software.

# BLUETOOTH CONTROL SOFTWARE



## DEFAULT SETTINGS

<b>Bluetooth Name:</b>	<b>WPBT-XXXX (XXXX is the last 4 digits of the Bluetooth MAC address)</b>
<b>Bluetooth PIN:</b>	<b>2626 (AMAM)</b>
Requires PIN:	Enabled
Connection History:	Remember last 8 devices
Pairing Timeout:	60s
Support Phone Calling:	Disabled
Audio Output Mode:	Stereo

If the default settings need to be changed, use the Bluetooth control software by following the instructions below.

## SOFTWARE SETUP

1. Download and install the Bluetooth Control software

*The Bluetooth control software is a free download from, [www.australianmonitor.com.au/pages/software-downloads](http://www.australianmonitor.com.au/pages/software-downloads)*

2. Connect the PC to the WPBT using a USB-C cable (not supplied)

*Note: 5V power will be supplied via the USB to the WPBT for programming. It does NOT require the +15V to 24VDC input power.*

3. Select the WPBT device from the connection window
4. Select the CONNECT button to connect to the WPBT
5. Make any changes required using the software controls

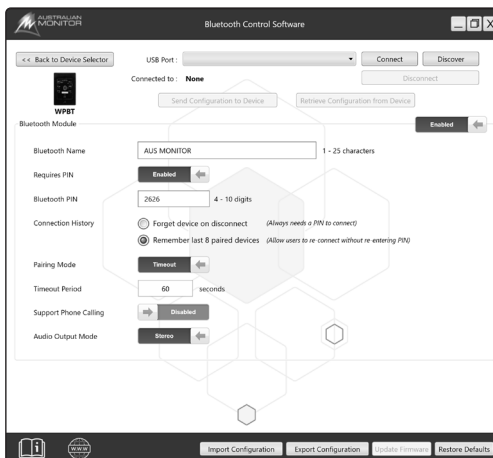

# WPBT WIRING



STEREO MODE

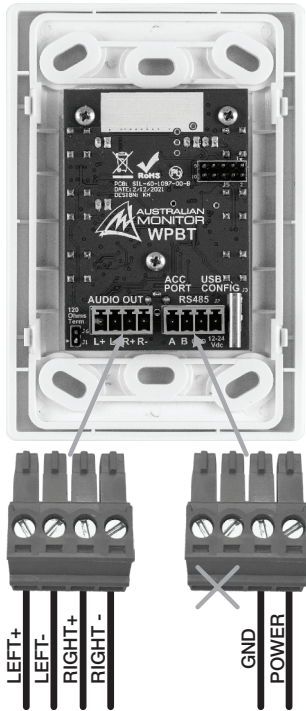

MONO MODE

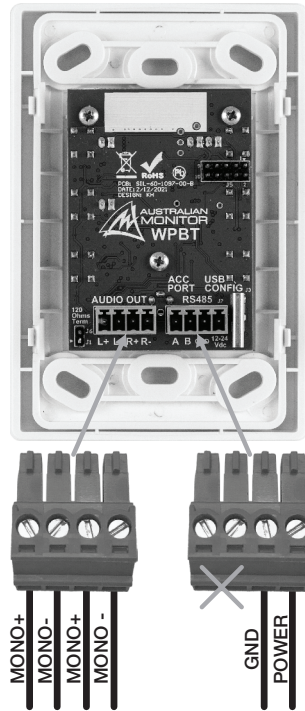

# WP-BREAKOUT ACCESSORY

The WP-BREAKOUT is an optional accessory box to easily provide power and break out the audio from up to two WPBT wall panels. +24V DC is provided to the wall panels and the wall panel balanced audio is converted into unbalanced audio for connection into any audio system.

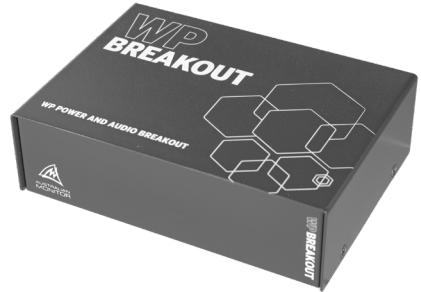

# WP-BREAKOUT WIRING

The optional WP-BREAKOUT accessory box is wired as shown below.

Pin	Colour	Signal
1	Orange/White	LEFT+
2	Orange	LEFT-
3	Green/White	Unused
4	Blue	+24V DC
5	Blue/White	GND
6	Green	Unused
7	Brown/White	RIGHT+
8	Brown	RIGHT-

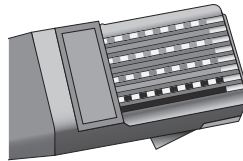

\*T-568B wiring

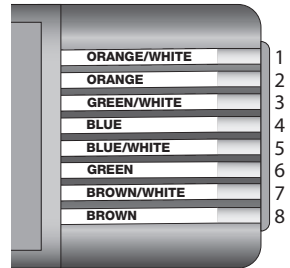

T-568B wiring recommended. However, T-568A also supported.



# SPECIFICATIONS



	WPBT	Comments
<b>AUDIO</b>		
INPUT CONNECTORS	3.5mm Front Auxiliary Input	
OUTPUT CONNECTORS	3.81mm Euroblock Balanced	
OUTPUT SENSITIVITY	1Vrms	
FREQUENCY RESPONSE	20Hz-20kHz	±0.5db
THD + N	< 0.1%	20Hz-20kHz, 20Hz BW, Unity Gain
SNR	> 80dBA	Max Output, 1kHz, 20kHz BW, A-Weighted
<b>BLUETOOTH</b>		
VERSION	Bluetooth v5.1	
PROFILES	A2DP Sink – Advanced audio distribution profile AVRCP – Audio/Video remote controller profile HFP Sink - Hands free profile	
RANGE	200m	Direct line of site. Walls and obstacles will reduce this distance
<b>CONTROL</b>		
USER CONTROLS	Front panel tactile push buttons	
COMMS INTERFACE	USB-C	PC Control Software
<b>POWER REQUIREMENTS</b>		
INPUT VOLTAGE	+15 to +24V DC	
INPUT CURRENT	50mA @ 15VDC 60mA @ 24VDC	
POWER CONSUMPTION	1.5W Max	
THERMAL DISSIPATION CONSUMPTION	5.2 BTU	1W = 3.412 BTU/Hr
<b>MECHANICAL</b>		
PRODUCT DIMENSIONS	82 x 32.7mm x 121mm ( 3.2"W x 1.3"D x 4.8"H)	
SHIPPING DIMENSIONS	156 x 132 x 101mm (6.1"W x 5.2"D x 4"H)	
NET WEIGHT	85g (0.19Lbs)	
SHIPPING WEIGHT	0.2kg ( 0.5lbs)	
FINISH	ABS Plastic	
COLOUR	White or Black	RAL 9010 / RAL9005
OPERATING TEMPERATURE	0°C to 40°C (95% RH)	
<b>APPROVALS</b>		
	CE, IEC, RCM	



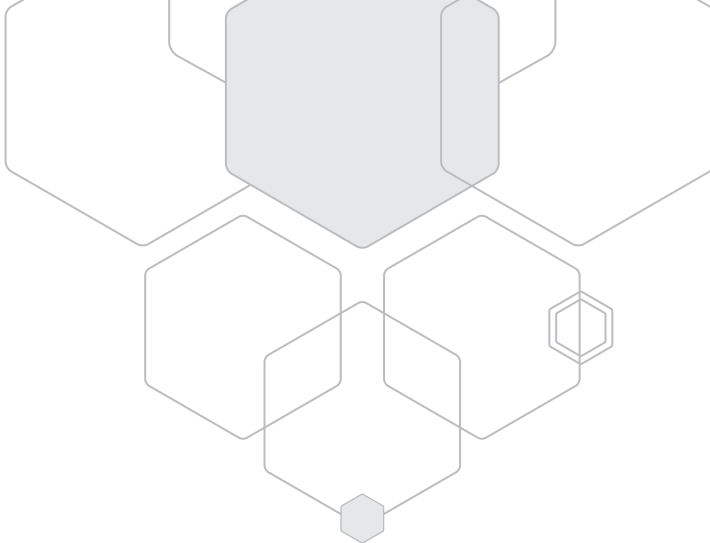

**ENGINEERED BY AUSTRALIAN MONITOR**

Address: Unit 1, 2 Daydream Street, Warriewood NSW 2102 Australia

Website: [www.australianmonitor.com.au](http://www.australianmonitor.com.au)

International enquiries email: [international@australianmonitor.com.au](mailto:international@australianmonitor.com.au)

ABN 86 003 231 187